

**BARBECUES :
ATTITUDE EX - EX+ - LX - LX+**

ATTITUDE EX



ATTITUDE LX



ATTITUDE EX +



ATTITUDE LX +



BARBECUES : ATTITUDE EX - EX+ - LX - LX+



ATTITUDE LX

- 5010005801 (Matte black / noir mat) - (Fr)
- 5010005845 (Glossy black / noir brillant)
- 5010006186 (Matte black / noir mat)

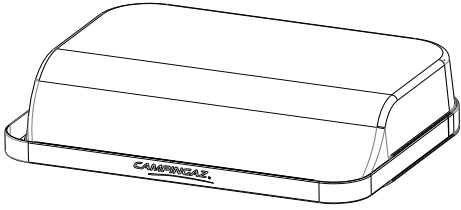

ATTITUDE EX

- 5010005798 (Glossy black / noir brillant)
- 5010005846 (Matte black / noir mat)
- 5010006169 (Matte black / noir mat)

- 5010005780
- 5010006185

5010005811

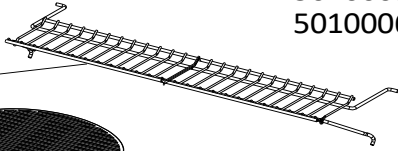

- (Fr)
- 5010005666
- 5010005786

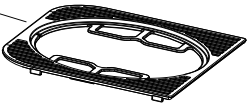

5010005814



5010005781

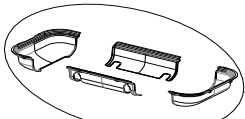

5010005788

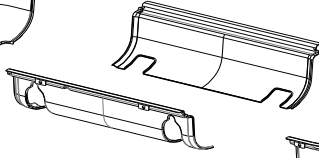
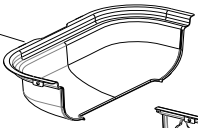

- (Fr)
- 5010005794
- 5010005800

- 5010005787 (28 Mb)
- 5010005796 (50 Mb)

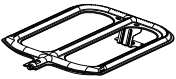

5010005797

5010005790

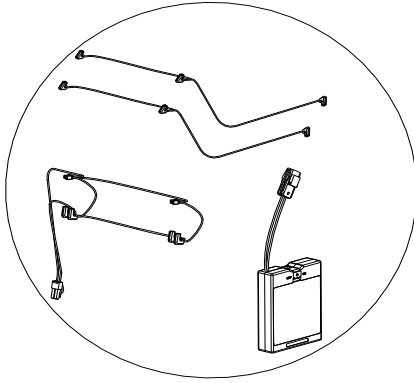
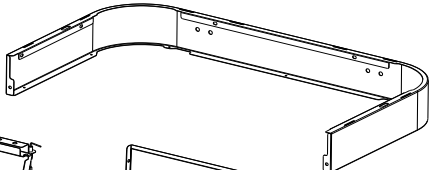
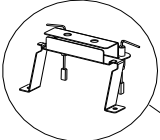

5010005797

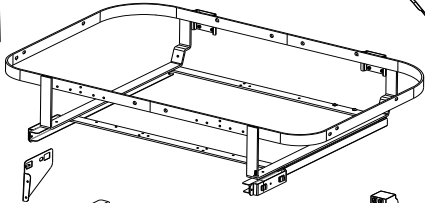
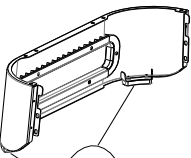

5010005810

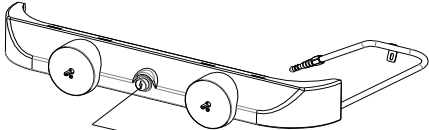

5010005805

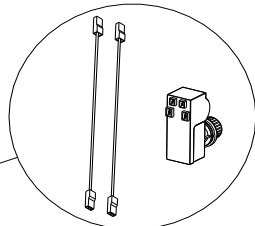
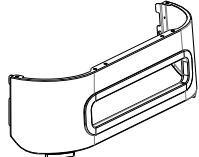

- 5010005783
- (ATTITUDE LX)

5010005834

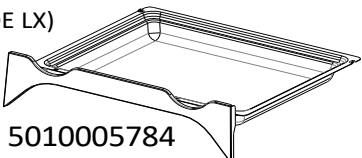

5010005784

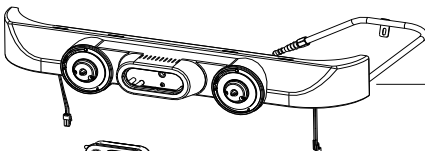

ATTITUDE EX

- 5010005807 (Export)
- 5010005816 (De)
- 5010005822 (Ch)



5010005791

- 5010005670
- (ATTITUDE EX)

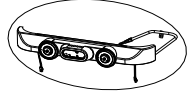

BARBECUES : ATTITUDE EX - EX+ - LX - LX+



SPARE PARTS REF.	POINTS	EN DESCRIPTIONS	FR DESCRIPTIONS	ATTITUDE EX	ATTITUDE EX +	ATTITUDE LX	ATTITUDE LX +
5010005666	260	ENAMELLED CAST IRON COOKING GRID (FRAME + CIRCLE) - SHINY (France)	GRILLE DE CUISSON FONTE EMAILLEE (CADRE + CERCLE) - BRILLANTE (France)			X	
5010005670	50	KNOB (x2)	VOLANT (x2)	X	X		
5010005780	70	THERMOMETER WITH NUTS AND 3 BEZEL (MOD. BEFORE 2021)	THERMOMETRE AVEC ECROUS ET 3 COUPELLES (MOD. AVANT 2021)			X	X
5010005781	50	LID PAD (x2)	PATIN POUR COUVERCLE (x2)	X	X	X	X
5010005783	50	KNOB (x2)	VOLANT (x2)			X	X
5010005784	120	GREASE PLATE DRAWER	TIROIR PLATEAU A GRAISSES	X	X	X	X
5010005786	260	ENAMELLED CAST IRON COOKING GRID (FRAME + CIRCLE) - SEMI SHINY	GRILLE DE CUISSON FONTE EMAILLEE (CADRE + CERCLE) - SEMI BRILLANTE	X	X	X	X
5010005787	120	STAINLESS STEEL BURNER 28Mb	BRULEUR INOX 28Mb	X		X	
5010005788	300	KIT OF REMOVABLE PARTS (FIREBOX)	KIT DE PARTIES AMOVIBLES (CUVE)	X	X	X	X
5010005790	50	KIT OF ELECTRODES + STAINLESS STEEL HOUSING	KIT ELECTRODES + SUPPORT INOX	X	X	X	X
5010005791	260	DIGITAL THERMOMETER WITH PROBES	THERMOMETRE DIGITAL AVEC SONDES	X	X		
5010005794	180	ENAMELLED CAST IRON COOKING GRIDDLE - SHINY (France)				X	
5010005796	100	STAINLESS STEEL BURNER 50Mb	BRULEUR INOX 50Mb	X	X	X	X
5010005797	110	BACKLIGHTING SYSTEM	SYSTEME RETRO-ECLAIRAGE	X	X		
5010005798	620	LID (GLOSSY BLACK) WITH HANDLE (MOD. BEFORE 2021)	COUVERCLE (NOIR BRILLANT) AVEC POIGNEE (MOD. AVANT 2021)	X	X		
5010005800	170	ENAMELLED CAST IRON COOKING GRIDDLE - SEMI SHINY	PLAQUE DE CUISSON FONTE EMAILLEE - SEMI BRILLANTE	X		X	
5010005801	670	LID (MATTE BLACK) WITH HANDLE AND THERMOMETER (MOD. BEFORE 2021)	COUVERCLE (NOIR MAT) AVEC POIGNEE ET THERMOMETRE (MOD. AVANT 2021)			X	
5010005805	50	ELECTRONIC IGNITION SET	KIT ALLUMAGE ELECTRONIQUE	X	X	X	X
5010005807	720	CONTROL PANEL + WIRES (BACKLIGHTING+IGNITION) + GAS PIPE 28Mb (Export)	CONSOLE + CABLAGE (ECLAIRAGE+ALLUMAGE) + TUBULURE 28Mb (Export)	X			
5010005810	50	RUBBER FOOT (x4)	PIED EN CAOUTCHOUC (x4)	X	X	X	X
5010005811	80	WARMING GRID	GRILLE DE MIJOTAGE	X	X	X	X
5010005814	200	ENAMELLED CAST IRON COOKING GRID - SEMI SHINY	GRILLE DE CUISSON FONTE EMAILLEE - SEMI BRILLANTE	X	X	X	X
5010005816	720	CONTROL PANEL + WIRES (BACKLIGHTING+IGNITION) + GAS PIPE 50Mb (De)	CONSOLE + CABLAGE (ECLAIRAGE+ALLUMAGE) + TUBULURE 50Mb (De)	X	X		
5010005822	720	CONTROL PANEL + WIRES (BACKLIGHTING+IGNITION) + GAS PIPE 28Mb (Ch)	CONSOLE + CABLAGE (ECLAIRAGE+ALLUMAGE) + TUBULURE 28Mb (Ch)	X			
5010005834	40	PUSH BUTTON ELECTRONIC IGNITOR	BOUTON POUSSOIR TRAIN D'ETINCELLES			X	X
5010005845	680	LID (GLOSSY BLACK) WITH HANDLE AND THERMOMETER (MOD. BEFORE 2021)	COUVERCLE (NOIR BRILLANT) AVEC POIGNEE ET THERMOMETRE (MOD. AVANT 2021)			X	X
5010005846	620	LID (MATTE BLACK) WITH HANDLE (MOD. BEFORE 2021)	COUVERCLE (NOIR MAT) AVEC POIGNEE (MOD. AVANT 2021)	X			
5010006169	660	LID (MATTE BLACK) WITH HANDLE (MOD. 2021 AND AFTER)	COUVERCLE (NOIR MAT) AVEC POIGNEE (MOD. A PARTIR DE 2021)	X	X		
5010006185	100	THERMOMETER WITH NUTS AND 3 BEZEL (MOD. 2021 AND AFTER)	THERMOMETRE AVEC ECROUS ET 3 COUPELLES (MOD. A PARTIR DE 2021)			X	X
5010006186	700	LID (MATTE BLACK) WITH HANDLE AND THERMOMETER (MOD. 2021 AND AFTER)	COUVERCLE (NOIR MAT) AVEC POIGNEE ET THERMOMETRE (MOD. A PARTIR DE 2021)			X	X